



DECENT MACHINERY

WWW.SCY-FAN.COM

Fog Cannon Brochure

ZIBO DECENT MACHINERY CO.,LTD

淄博鼎威机械设备有限公司





Cannon Models



All products have CE, ISO, SGS, BV, TUV, SABER certification



Application



Demolition & Construction



• RECYCLING PLANTS •

Landfill



Street Cooling

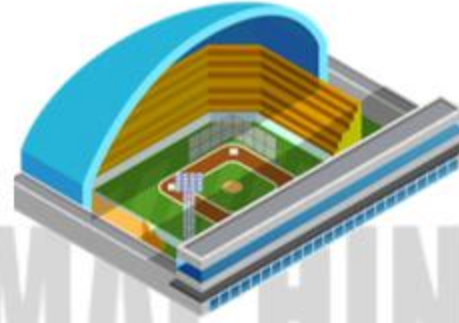

Stadium Cleanup



Theater Disinfection



Sewage Treatment



Sewage Treatment



Mining and Quarrying



Steel and Slag



Disinfecting Spray



DECENT MACHINERY

Why choose Decent?

People are afraid of two things.

First is quality and it is obvious. Second is communications. Because they think that if communication is not good during negotiation, in future in case of problems it could only be worse. Thus people are afraid if they see that answers take long time to arrive during negotiation, or if questions are not properly answered.

Many suppliers do not know this and do many mistakes. But we have long experience in dealing with customers from over 120 countries.

We sincerely welcome you to visit factory before loading the containers, In case you cannot visit China then we will help you to hire a legal third party company for inspection to make you assured.

Decent promises to conduct noise and physical inspections via video conferencing.

Decent Machinery Support all-round video inspection of product quality before placing an order, and support livebroad test machine.



DECENT MACHINERY

Services

Contact information:

Salesman:sales1@decent-machinery.com

Supervisor:rita@scy-fan.com

Department for complaint:service@scy-fan.com

Emergency contact: manager@scy-fan.com

Thanks for choosing DECENT MACHINERY among plenty of Chinese suppliers.

We do cherish the opportunity to do long-term business with you.

To show our sincerity,we promise:

You will have at least 4 contacts to get timely services:

A

B

A video conference between you and DECENT MACHINERY technical department will be held before fabrication,all technical details will be discussed and analyzed face to face,to avoid any mistake.

After conference,sales will share a memo for final confirmation,and arrange production immediately.

C

D

At every stage of the production process, DECENT MACHINERY will share photos and videos to show status of production in every 3 days.

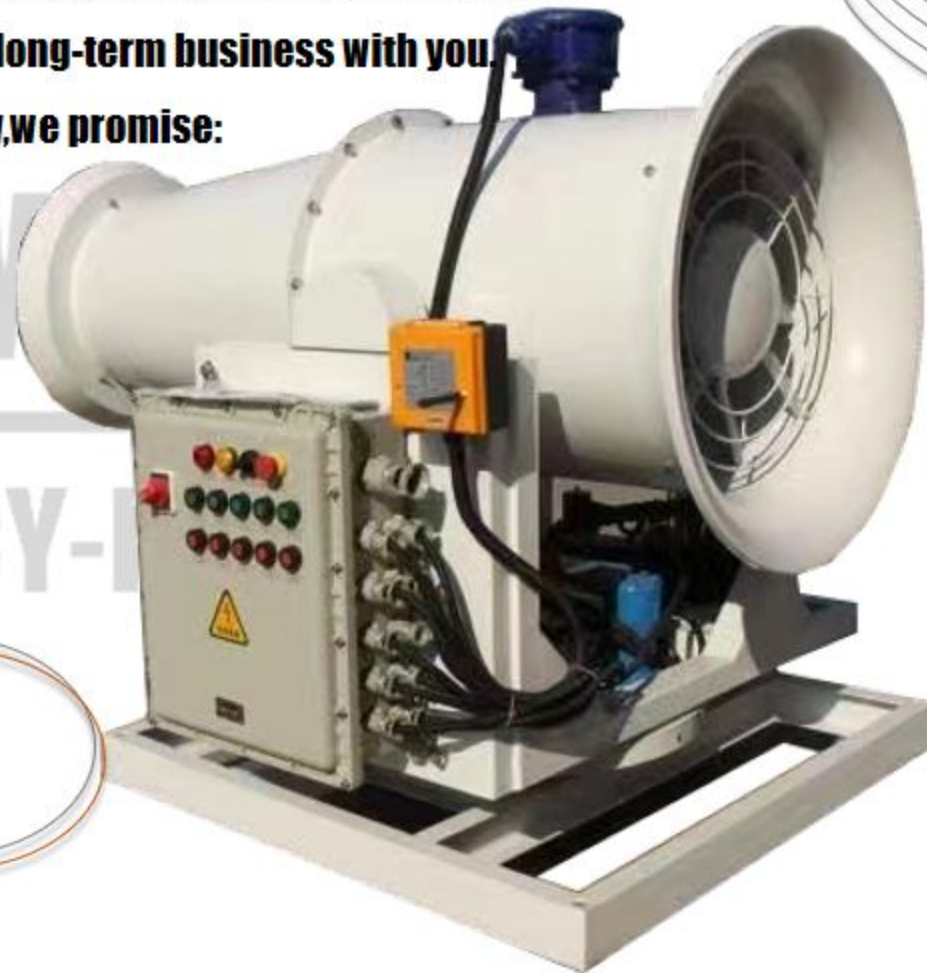



DECENT MACHINERY

E

To ensure the smooth delivery,DECENT MACHINERY will contact you if there's anything need help during production. Thanks for your support in advance.

Each order has a unique number, which is used to track the progress of the order. You can quickly find all the status of your order from our website (www.scy-fan.com), including production,installation,testing,packing,loading,shipping progress, etc.

F

Contact information:

Salesman:sales1@decent-machinery.com

Supervisor:rita@scy-fan.com

Department for complaint:service@scy-fan.com

Emergency contact: manager@scy-fan.com

G

After goods have been received,maintenance advice provided by DECENT MACHINERY's service department from tome to time.

DECENT MACHINERY's service department will share product knowledge and new technologies every week,help you grasp market trends better and win more opportunities.

H

Appreciate for your trust and support



DECENT MACHINERY



Video technical meeting

Scheme design
Technical support

Visualization of the production process

Videos and pictures will be fed back to each step of the production.



Services



Memo confirmation

Order requirements and details are sorted and confirmed.

Order tracking

Each customer has a unique customer number. You can search for the number on the tracking page of the official website to check the order status.



Logistics

High quality of our services



DECENT MACHINERY

Introduction

Fog cannon (also known as **mist cannon**, **dust removal**, **dust suppression cannon**, **spray cannon**, ect.) is designed for effective dust control. Spraying the fine mist, which help to minimize the dust, reduce the health risk and improve air quality.

Dust suppression



Decent Fog Cannon has been designed to tackle the problem of airborne dust particles generated by open mining activities, general demolition work and bulk material handling. Fog Cannon has been shown to suppress up to 95% of airborne dust particles. And the long throw distance is usually necessary for this. Fog Cannons are also useful for dust suppression of stockpiles where their low water use is an advantage.

At present, in many open yards and operation sites, operation dust and local dust are the problems of dust control. As a professional manufacturer of dust removal equipment, we can design a long-range spray solution for customers according to the actual pollution situation on site and the amount of dust to achieve the ideal dust control effect.



DECENT MACHINERY

Regarding the product issue, when you purchased last year, it happened to be the most severe period of the epidemic. The number of products is limited but the demand is large, so the price is high. After more than a year of hard work, at present, China's domestic epidemic has been controlled and has been relatively stable. The demand for such products in the market has dropped significantly, and prices have also fallen. If you are interested, we can update the latest price to you.

Although the price of the mist machine is relatively cheap, the maintenance cost is high in the later period. The damage of the battery and the motor needs to be replaced regularly, and the noise is relatively large. It is recommended that you consider a Fog Cannon.

After more than a year of anti-epidemic experience, we have also developed a variety of disinfection products according to different market needs. Among them, the best-selling and most advantageous one is the Fog Cannon. Fog Cannon can be used in a wide range, including: disinfection of various places, theater disinfection (ultra fine mist can be made, and seats will not get wet), agricultural insecticide, irrigation, mine dust removal, cooling, etc. Attach an brochure for your reference.

This product has a wide market, considerable profit, and good prospects. It is favored by many customers. If you are interested, you can consider promoting and selling as our agent in Guatemala. We will provide you with the most favorable and comprehensive plan.



Working principle

The fog cannon is based on the principle of air delivery, first use a high-pressure pump and a fine atomizing nozzle to atomize water, and then use the air volume and wind pressure of the fan to send the atomized water mist to a longer distance, so that the water mist reaches a longer distance and can cover more large area, water mist and dust will land after condensing, so as to achieve the purpose of dust reduction.

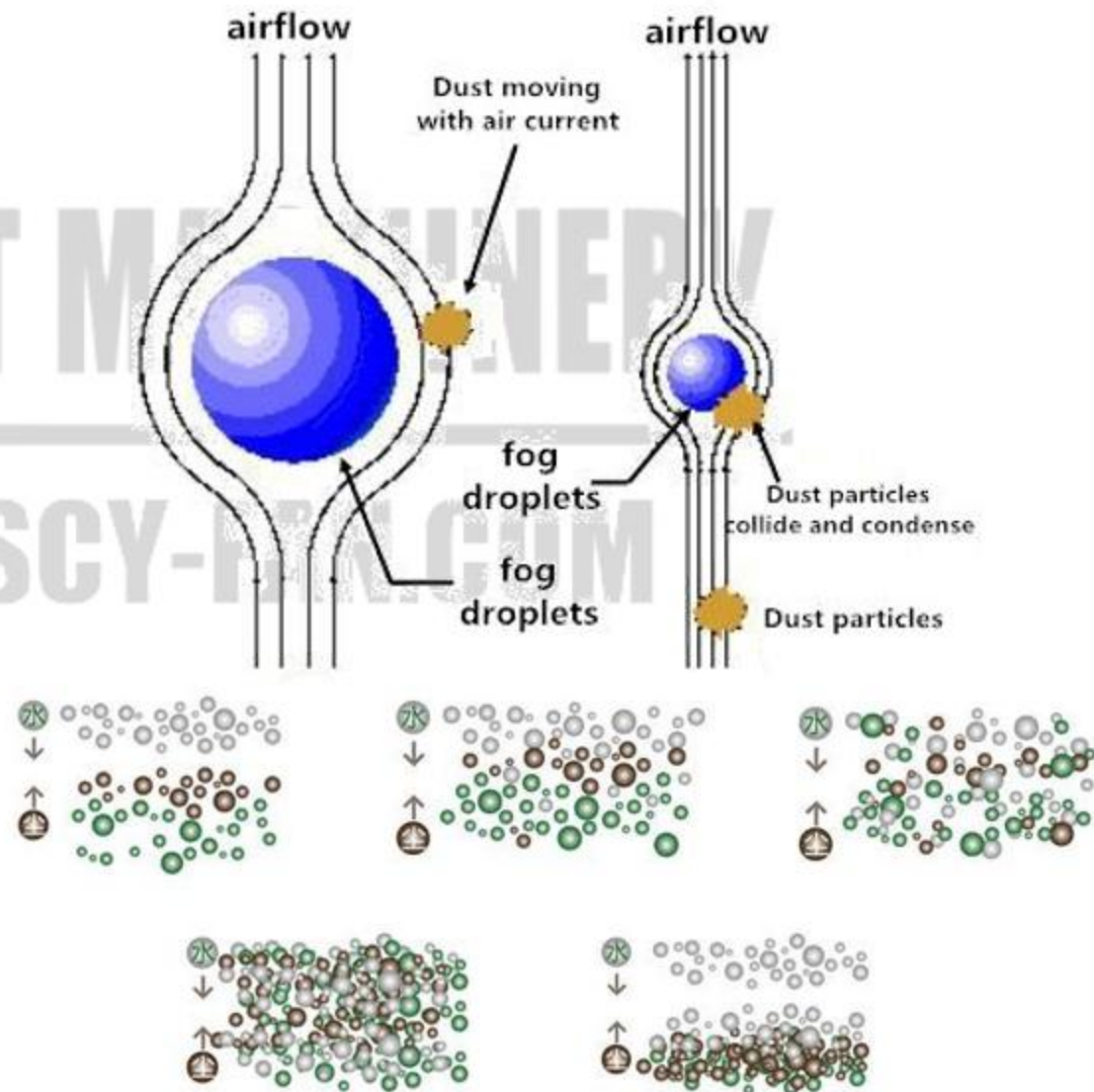



DECENT MACHINERY

Throw distance introduction

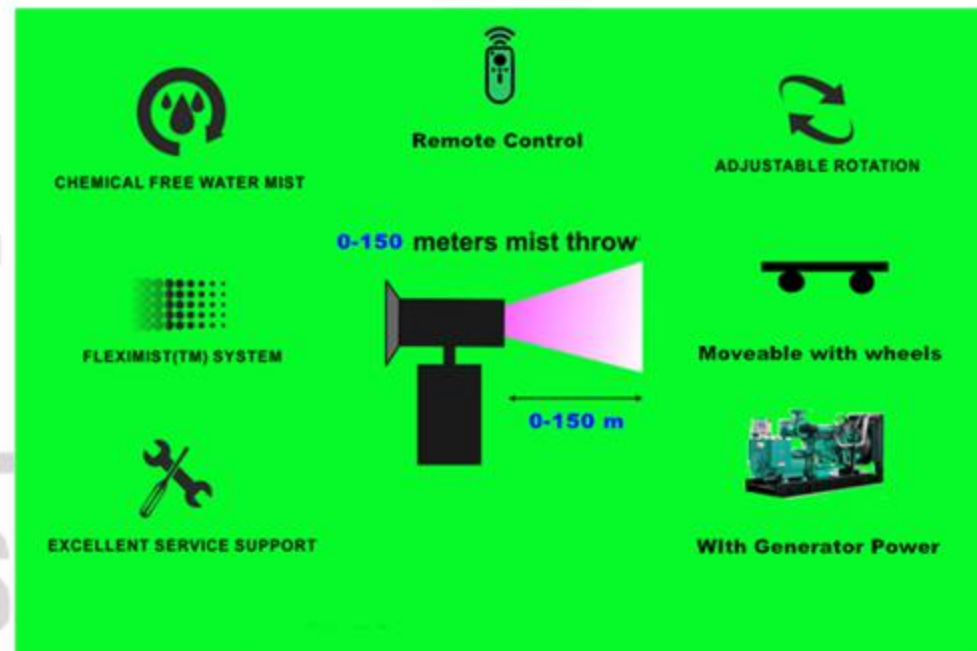
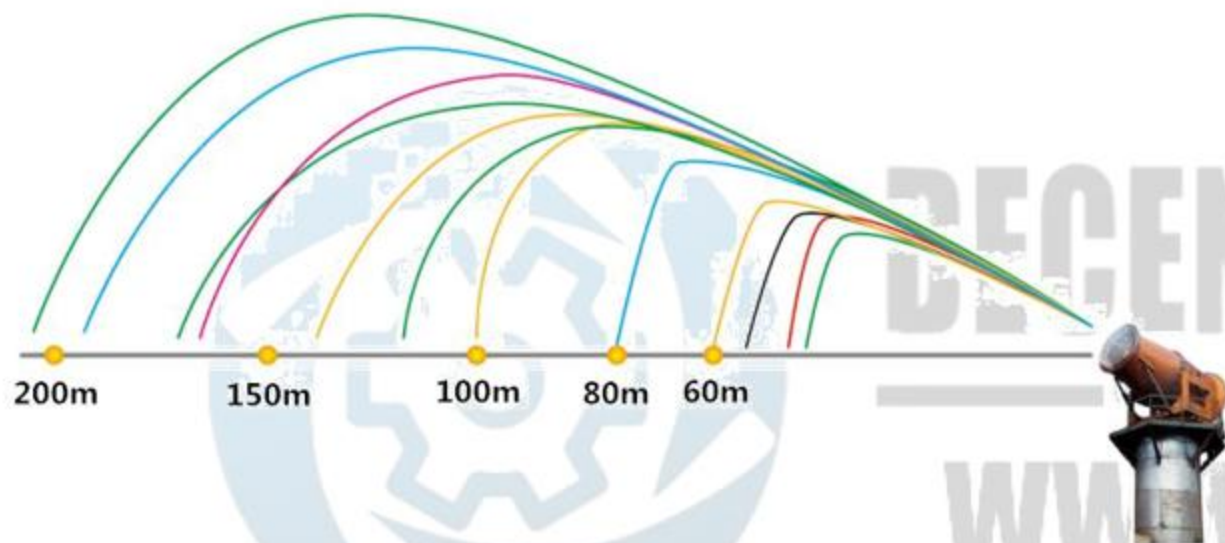

- The models of fog cannon range from 30 meters to 200 meters.
- Customers can choose models according to actual needs, or we can recommend models through the place of use.
- 30-60M applied in Cooling & Sterilization, 80-200M apply to Dust Suppression.



DECENT MACHINERY

Struction

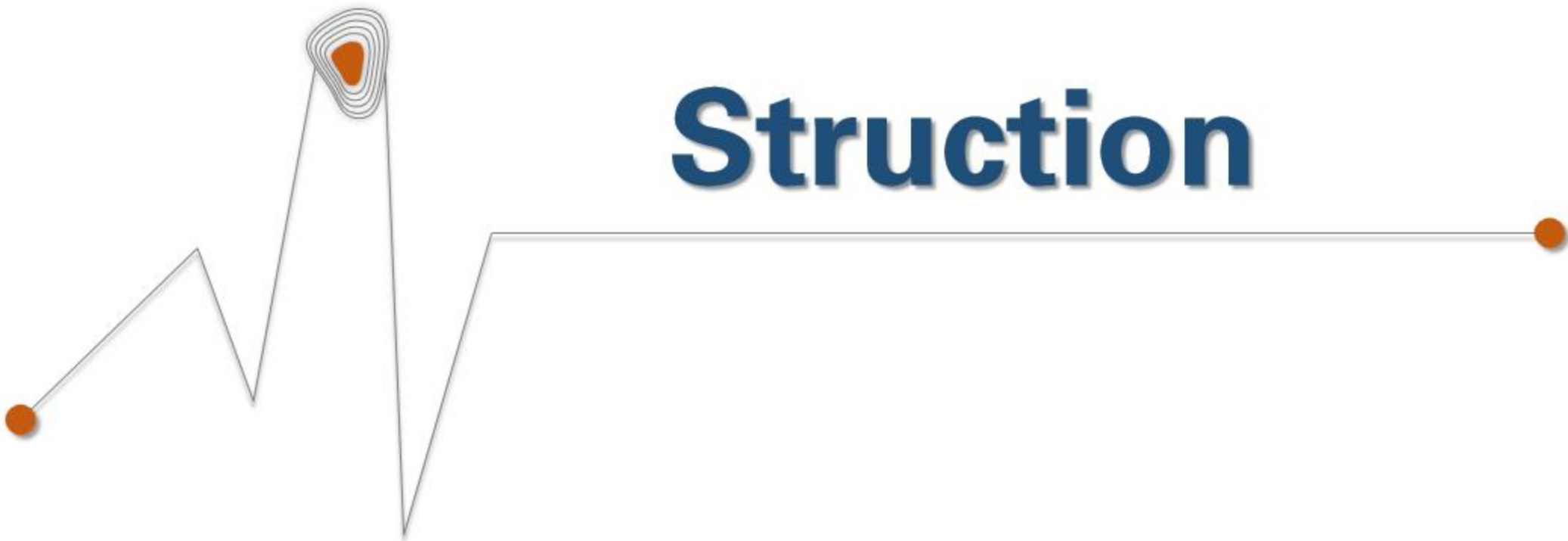



DECENT MACHINERY



Impeller



Receiver



Cannon Body



Nozzle & Nozzle Ring



Protection net

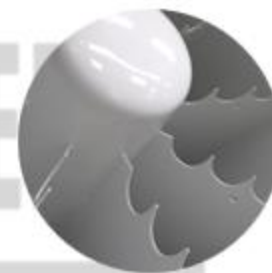

Guide vane



Control cabinet



Hydraulic prop



Base



Water pump

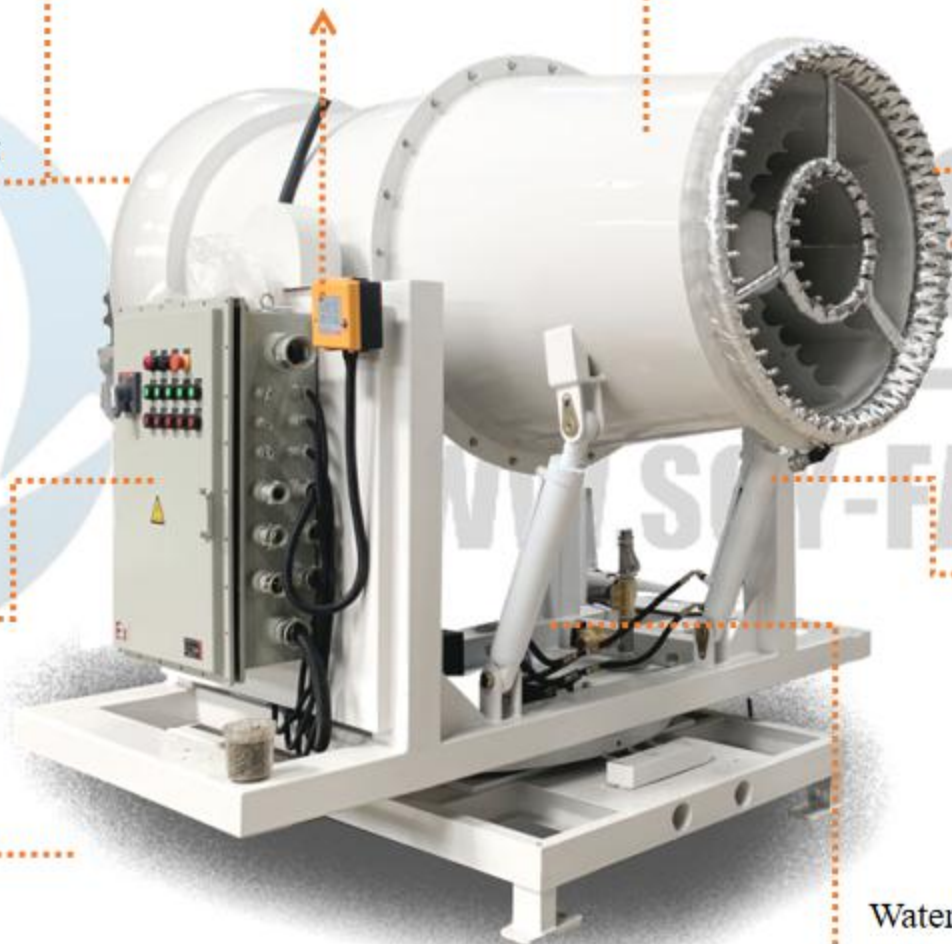

CHINESE
WWW.SOY-FAN.COM



DECENT MACHINERY

Feature & Advantage

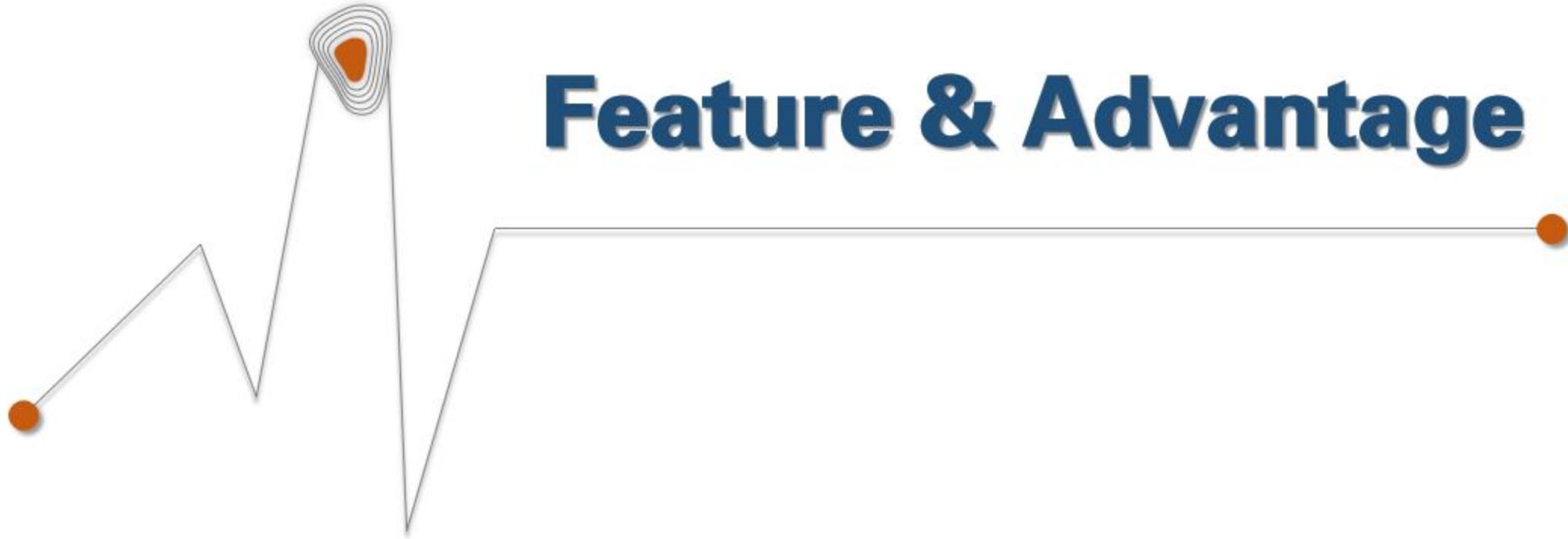



DECENT MACHINERY

Feature

- Easy to install and operate.
- Low energy consumption.
- Effective and durable.
- Low investment cost.
- Tailor-made solutions.
- Different types of buildings.
- PLC control and remote control within 300 meters.
- Droplet diameter 30-150 microns.
- Hydraulic pump station controls the rotation, which is more stable and durable.
- Aluminum impeller reduces power consumption.
- 320 degree rotation, large area coverage.



Rotation system

motor

Vertical rotation: motor driven
Horizontal rotation: motor driven

motor & Hydraulic

Hydraulic system: hydraulic prop + hydraulic motor
Hydraulic pump station (power unit) provides power

Vertical rotation: hydraulic support rod
Horizontal rotation: motor driven

Full hydraulic

Hydraulic pump station: hydraulic oil container + motor generally 0.75kw

Vertical rotation: hydraulic cylinder (hydraulic prop)
Horizontal rotation: hydraulic motor

DECENT MACHINERY
WWW.DJ-TAN.COM

- Hydraulic oil is detected once in 100h, and it can also be judged according to the oil level on the hydraulic pump station
- Oil change time: 300-500h

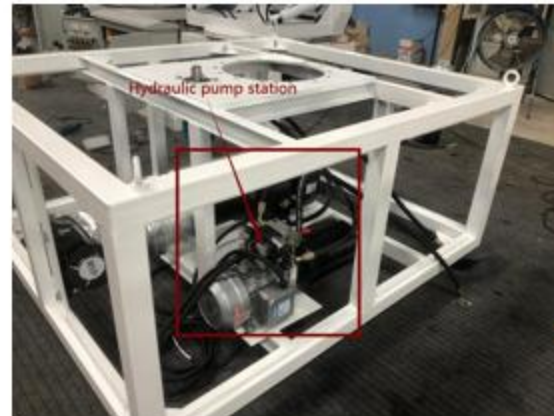

Water pump

Plunger pump

30/40米
Low cost

Vortex pump

≥50Meter

Centrifugal pump

≥50 Meter



- High-pressure pump: 500h oil change, short service life
- Low-pressure pump: maintenance-free
- Imported nozzle with low pressure pump (average droplet 30 μ m, no wet ground)
- Domestic sprinkler with high pressure pump

Lower cost than the centrifugal pump.

Replacement of the centrifugal pump

WWW.SCY-FAN.COM



Fog particle size: 20~200 μ m



Up to 30 μ m, but not the average, and
the ground will be wet

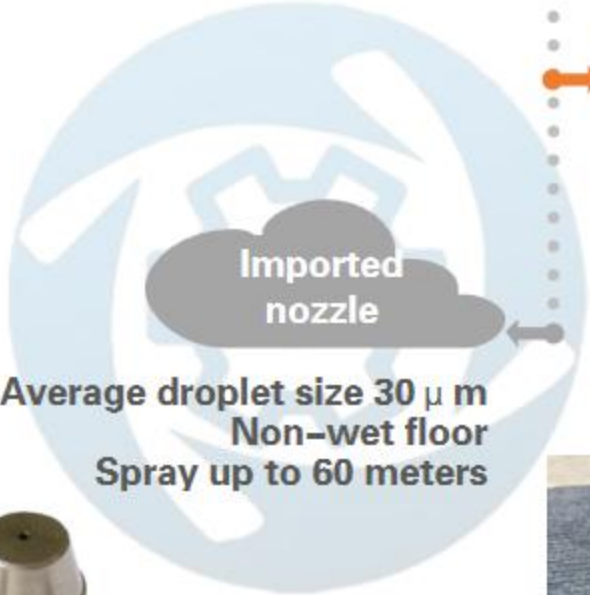

Average droplet size 30 μ m
Non-wet floor
Spray up to 60 meters



Nozzle

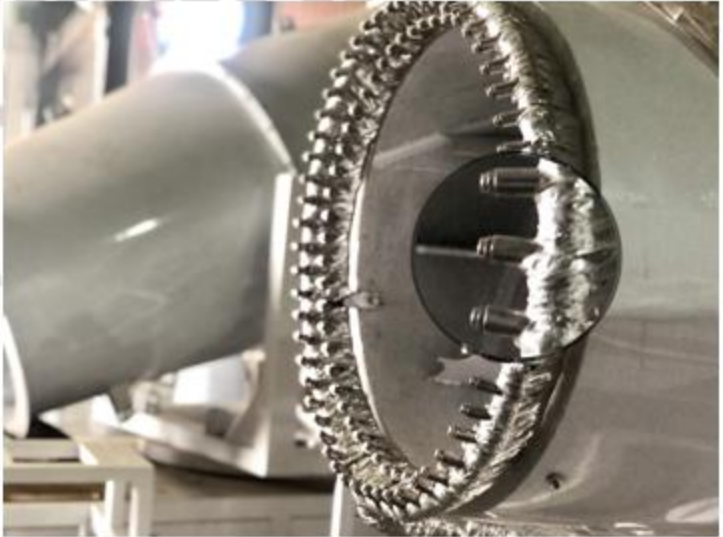

SCY-MACHINERY
WWW.SCY-FA

Rubber shock absorber

Damping effect: 75-80%

Spring shock absorber

Damping effect: 80-85%

Air Shock absorber

Damping effect: 85-95%

TYPE 19 Spring shock absorber

Damping effect: 95-98%

Shock absorber

- Is a use of damping characteristics to absorb or suppress impulse, mechanical or hydraulic means so as to slow down and dissipate the kinetic energy of the mechanical vibrations.



Advantage-Class comparison

Item	Class A	Class B	Class C
Noise	89DB	95DB	100DB
Thickness of carbon steel	2.5mm	2.0mm	1.5mm
Water Pump	Stain steel multistage centrifugal pump	Multistage centrifugal pump	High pressure plunger pump
Rotating structure	Hydraulic prop	Hydraulic prop	Motor drive
Nozzle type	Ultra fine mist Import from America Non-wet floor Average droplet size 20-30µm	Ordinary nozzle	Ordinary nozzle
Control type	VFD start	soft start	soft start
Remote control distance	300m	100m	100m
Generator set	Generating set silent box	Generating set silent box	Generator normal box
Painting	Three layers painting: 1.Prime(Prime) 2.powder paint 3.220° baking varnish	Three layers painting: 1.Prime(Prime) 2.powder paint 3.220° baking varnish	painting
Tires	Tubeless tyre	Tubeless tyre	Solid tire
Trailer	2-axle heavy industry trailer 10 tons load	Full-trailer 5 tons load	Full-trailer 2 tons load



Class A



Class B



Class C



DECENT MACHINERY

www.scy-fan.com manager@scy-fan.com

3 Types of Quotation

CLASS B

CLASS A

CLASS C

A

- The best material and quality.
- With World famous brand motor such ABB/SIEMENS/Weg/TECO and etc
- Excellent welding with ultrasonic weld inspection test
- Longer guarantee period to 3 years
- **Live** video for the running test, electricity current test, balancing test
- Test report letter before delivery

B

- The good standard material and quality.
- With Chinese famous brand motor with trustable guaranteed quality.
- Standard welding, impeller balancing.
- Video for running test, electricity current test.
- Guarantee period to 18 months
- Test report letter before delivery

C

- The **bad** material and quality.
- With economical quality local motors
- Standard economical welding, impeller balancing.
- Guarantee period to 10 months





DECENT MACHINERY



Plastic



Stainless steel



Carbon steel



Stainless steel

WATER TANK

TRAILER

**Optional
Parts**

MATERIAL

GENERATOR SET

Independent trailer

Water tank trailer integrated

Open generator

Silent generator





Average droplet particle diameter: 30-150 μ m



Average droplet particle diameter: $\leq 30\mu$ m



Motor controlled rotation



Hydraulic pump station controls rotation

**NOZZLE
TIRE**

**Optional
Parts**

**ROTATION SYSTEM
WATER PUMP**

China Local Brand

ABB/Siemens/TECO optional





DECENT MACHINERY

Small atomized particle water mist concentration

Easy to disassemble and clean up

Use the rocket head type central spray,
water mist concentrates, and spray pressure is big.

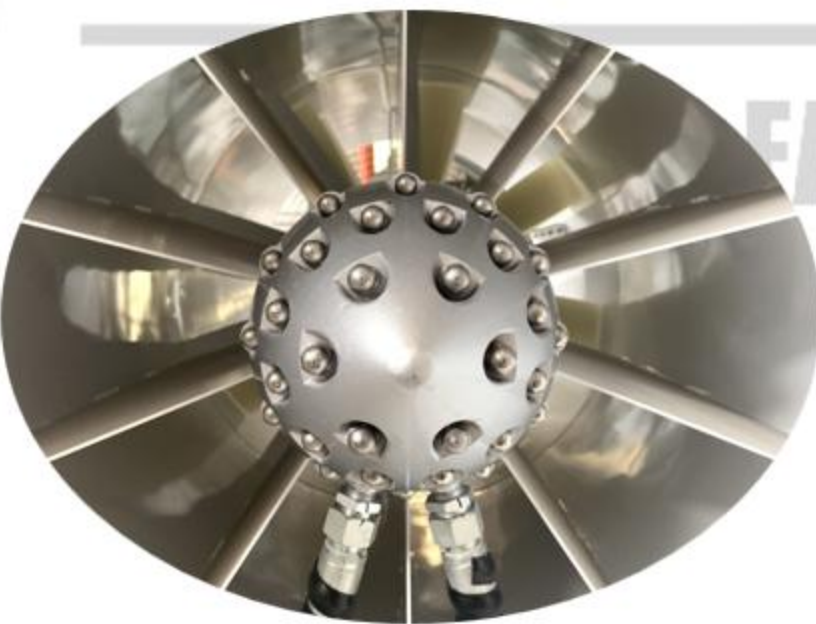
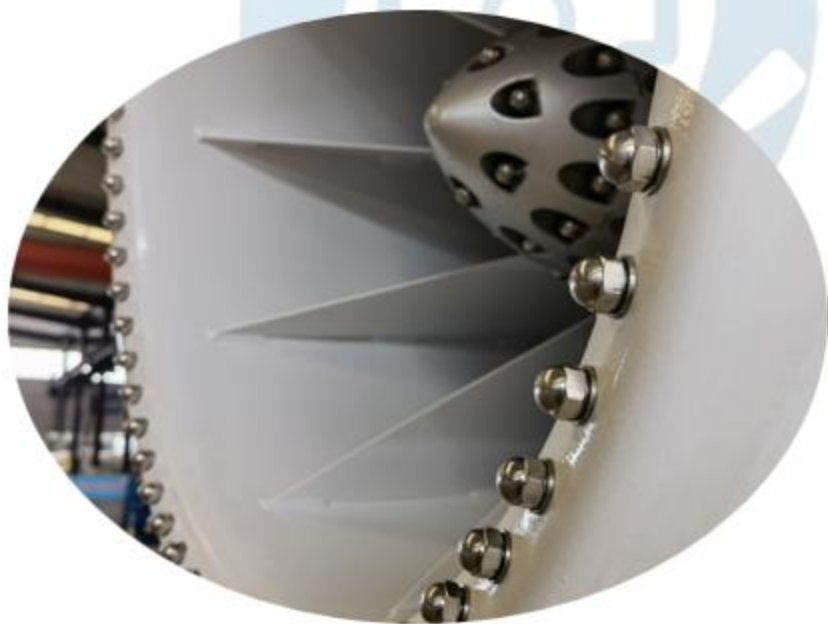

FAN.COM



DECENT MACHINERY

Strong wind and low noise

Nylon nolded plastic

1. Good uniformity and dynamic balance
2. Invariant
3. Small Noise
4. Strong wind

DECENT MACHINERY
WIND-FAN





DECENT MACHINERY

Touch screen operation Remote Control

Touch screen: visual operation, easy operation

Remote Controller: transmission distance up to 100M





DECENT MACHINERY

Stainless steel housing

Corrosion protection

Wear-resistant

DECENT MACHINERY

COM





DECENT MACHINERY

Thickness

Thicker than your phone

2 times the plate thickness of other products

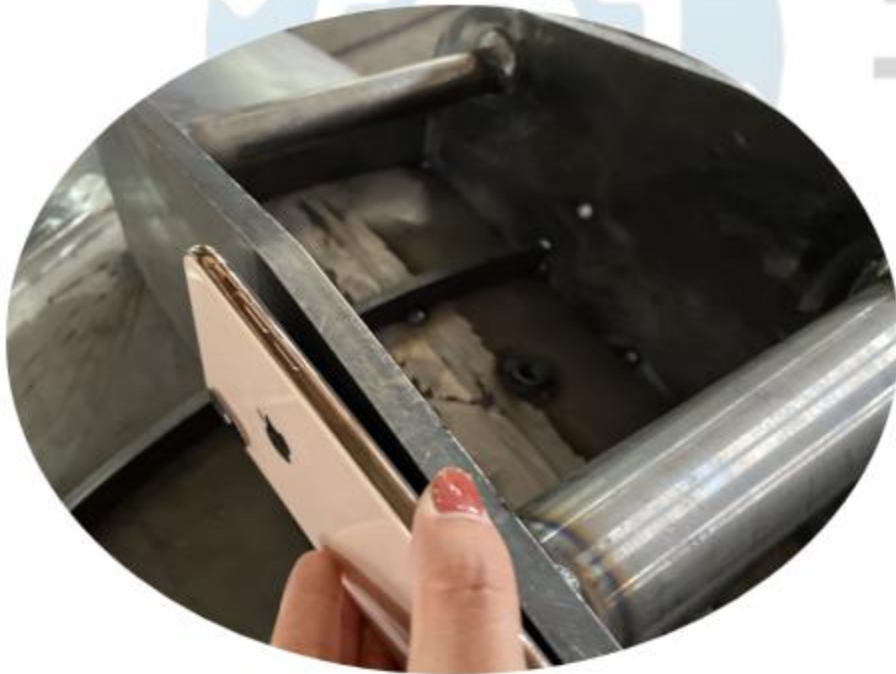

DECENT MACHINERY
COM



DECENT MACHINERY

Stroke limiter

When the equipment runs to a fixed position, the limit baffle touches the lever of the travel switch to cut off the power supply that controls the walking, and the equipment can only run in the opposite direction when it is closed again.

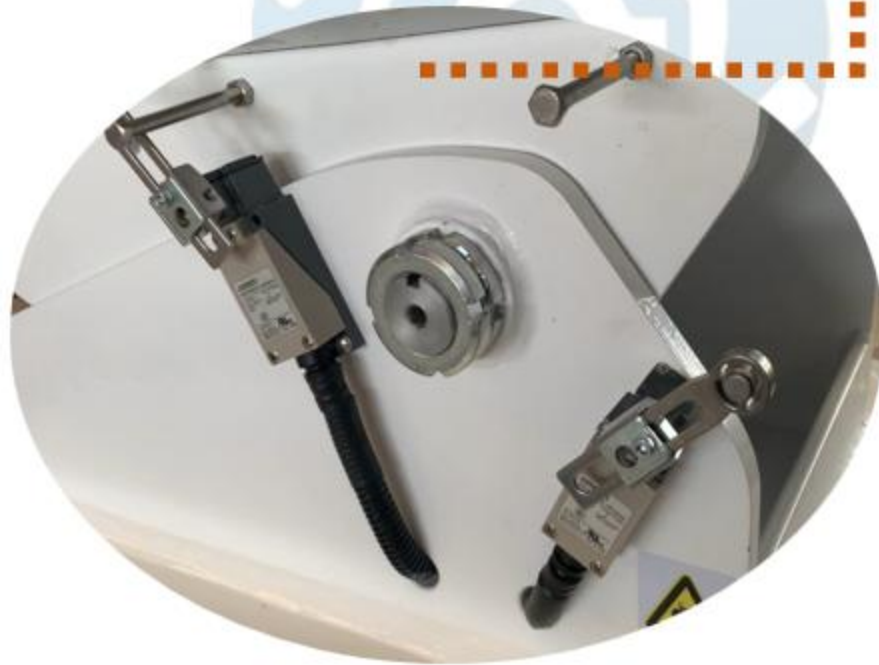



DECENT MACHINERY

Rock wool silencer cotton

- Reduce the noise level of equipment
- Laminated porous material with step density, which are all holes having connectivity, and will bore wall friction material after the sound inlet, the energy can be converted to sound reduction effect can be achieved.





DECENT MACHINERY

Spraying process

Shot blasting



Pickling



Spraying



DECENT MACHINERY



No Electricity Fog Cannon for Mining

- New research and development technology.
- The range and coverage area can be changed by adjusting the overall tilt angle and nozzle angle, covering a diameter of more than 60 meters (the greater the pressure, the greater the coverage),a booster pump can be configured.



Feature

- Without power supply, is formed entirely remote Air - spray high-pressure water through its own reaction force rotation of the fan.
- 360 degree continuous rotation.
- Configurable mechanical automatic spray valve to realize automatic spraying of tunneling surface.
- Fixed, pitch, and three-dimensional rotation speed can be continuously adjusted at will.
- The water mist has a long range, a cylindrical shape, a large dust-catching volume, and fine and uniform mist particles.
- Simple installation, low cost, long life span, and can achieve 5 years of maintenance-free.
- Saving more than 80% of the ground 150 meters underground without electricity, saving 100%, it is the old fog cannon replacement products



Pressure pump can be configured if the pressure is not enough, our company can customize according to needs!



DECENT MACHINERY

DM-20



Sprayer Throw(M)	20
Nozzle	16(Single Ring)
Material	Carbon steel--2.5mm
Working Temperature(°C)	0-60
Working Pressure(Mpa)	1.5-6
Inlet diameter	DN40-100
Flow Rate(L/min)	Adjustable
Horizontal rotation angle(°)	360



DECENT MACHINERY

Design Drawing

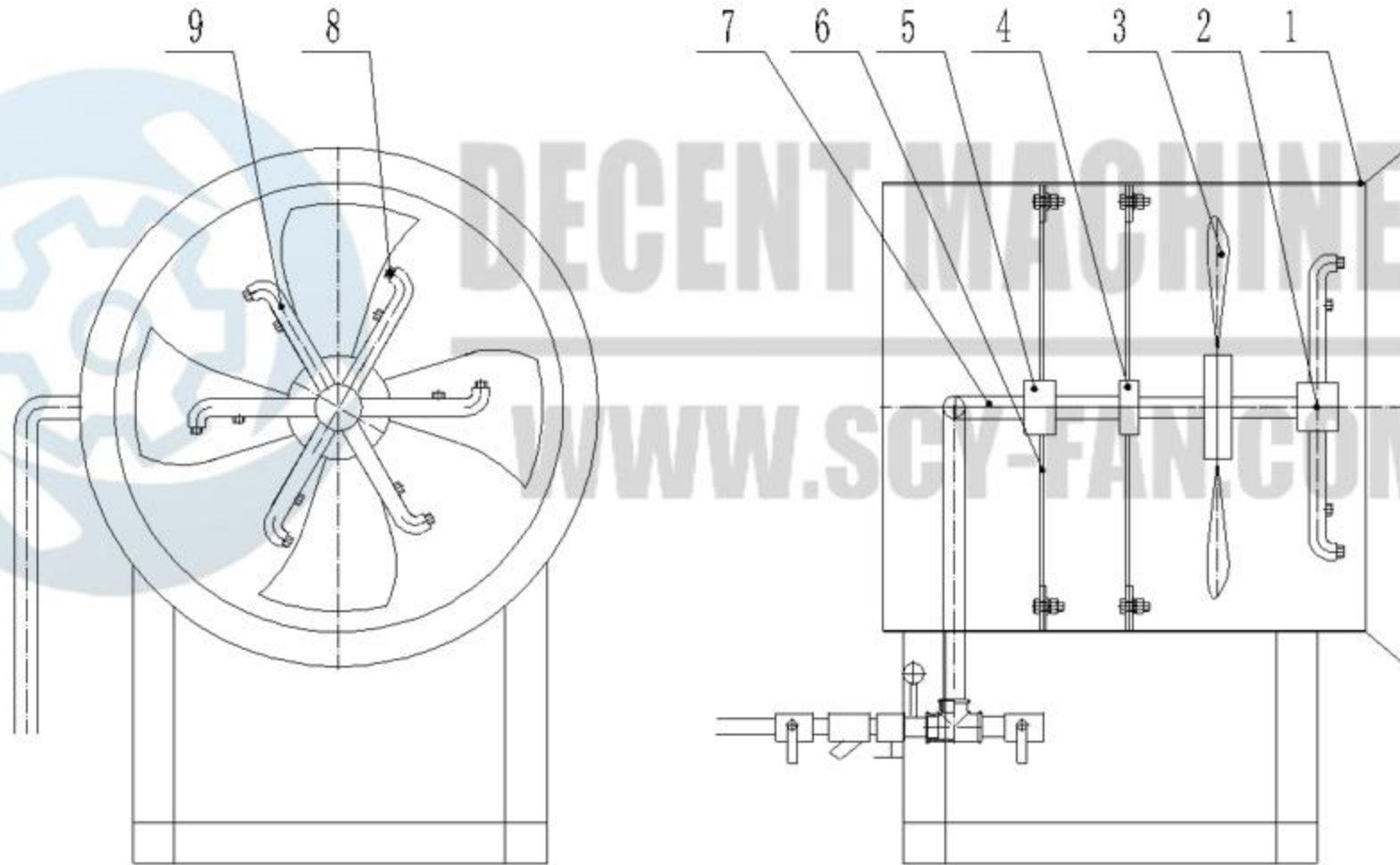



Concept and scope of application

- The mine-use wet dust-removing no electricity fog cannon is a kind of mine-used high-pressure micro-mist dust removal equipment that is simple in structure and relies on high-pressure water rotation.
- This fog cannon is suitable for dust treatment of multiple dust sources such as fully mechanized coal mining face, moving frame, belt, transfer head, drum and so on. Especially the treatment of the dust generated by the drum that is difficult to handle; it is also suitable for the treatment of dust inside the ground space, the product is in the jaw crusher, the cone crusher, the mixing station silo, the sand and gravel production line, the cement factory, the brick factory, the stone factory, the coal shed It has also been widely used. Compared with traditional suppression equipment, it has a great advantage in controlling dust. It is an ideal device for dust suppression and dust suppression.





DECENT MACHINERY

Applicable place



Underground excavation



Underground tunnel



Coal mine



Building cooling down



Landfill site



Site dust suppression



Suspended Evaporator

- New research and development technology.
- The range and coverage area can be changed by adjusting the overall tilt angle and nozzle angle, covering a diameter of more than 60 meters (the greater the pressure, the greater the coverage),a booster pump can be configured.



DECENT MACHINERY

Feature

- Voltage 380V, 50HZ power supply, other voltages can be customized.
- Low power consumption and strong continuous working ability. All seals of the equipment adopt maintenance-free equipment, which can ensure continuous operation without shutting down under normal conditions, and it is overhauled once a year.
- The high-speed rotating impeller breaks the water into small droplets of 100-400 μm in size to form water mist, which evaporates under natural weather conditions with high evaporation efficiency.
- Install on the water surface of the evaporation tank to ensure that all unevaporated liquids and pollutants fall back into the evaporation tank. Will not cause pollution to the outside world.
- Evaporated water volume per hour is about 4-10 m^3

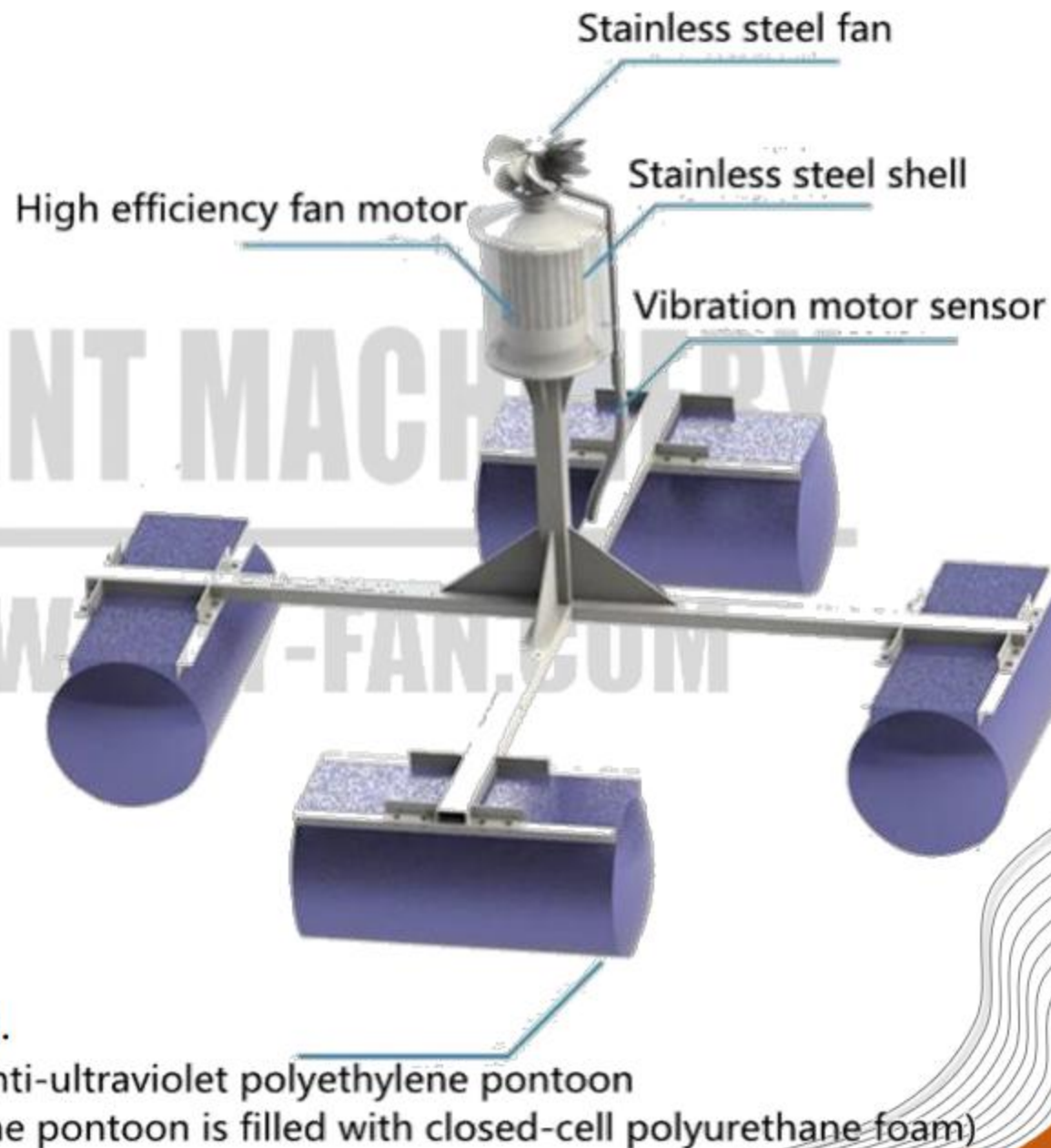



DECENT MACHINERY

Working Principle

The high-speed blade breaks the liquid to form 100~400 μ m droplets



Water Vapor

The tiny droplet particles are affected by sunlight (temperature) and airflow (humidity), the solvent quickly evaporates to form water vapor, and the solute falls into the pond

Evaporation Pond Solute



- The motor is installed on the floating platform through the support column, the power output shaft of the motor is provided with an impeller, the water pump is fixed under the floating platform, and the outer wall of the motor is fixed with an annular spray hole. The water outlet is located below the impeller.
- The high-speed rotating impeller breaks the water into small droplets of 100 microns in size to form water mist and evaporate using natural weather conditions. Forced evaporation: It can enhance the evaporation effect by 14-30 times, and the evaporation pond area required to evaporate the same wastewater can be reduced to 1/10 of the original. Automatic control: According to the time-controlled timing operation and wind speed, the mechanical atomization evaporator is automatically closed and started.



DECENT MACHINERY

Application



AC
WWW.SDY.FAN.COM





DECENT MACHINERY

Design Drawing

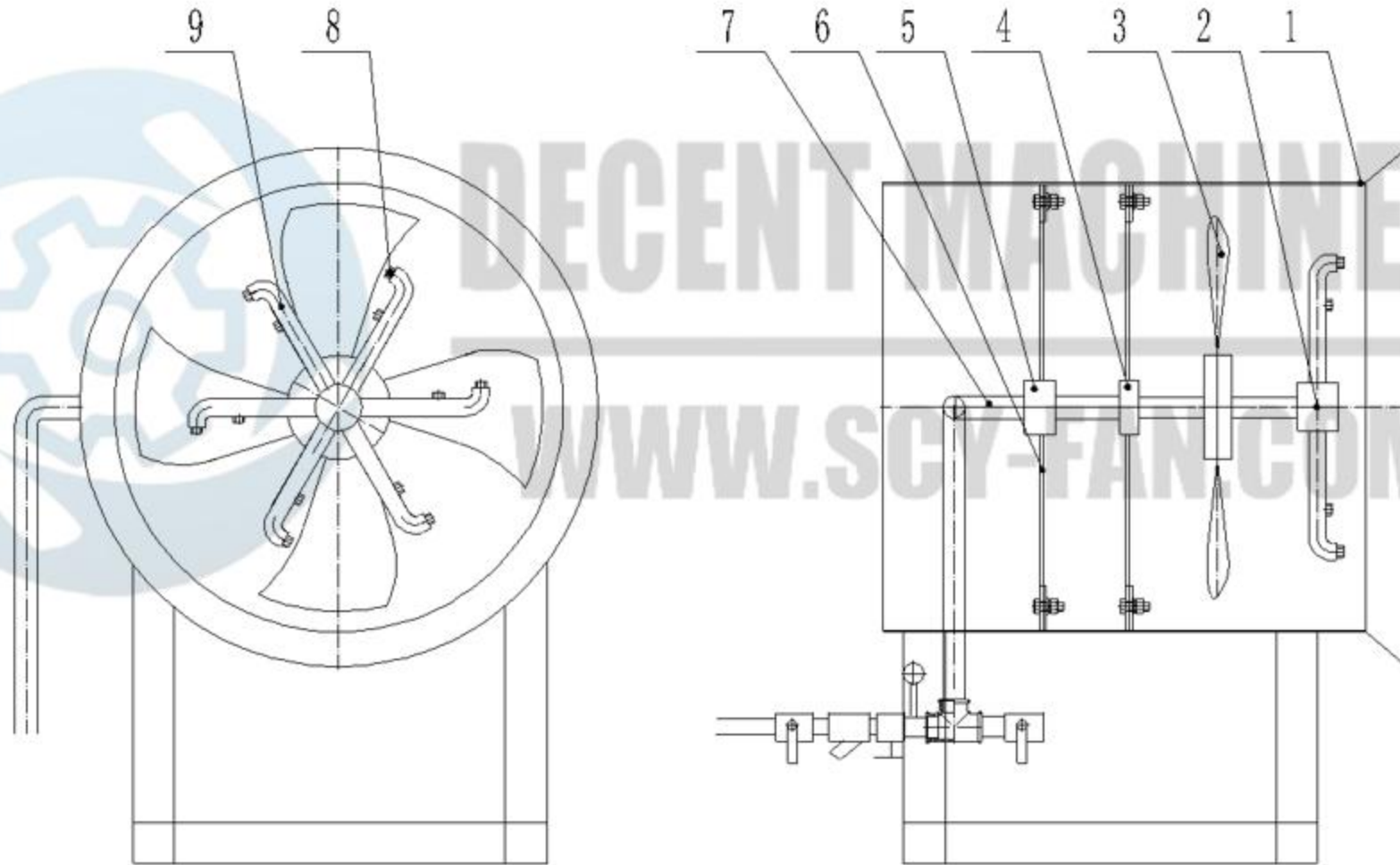



DECENT MACHINERY



Parameter

Model	Fan Power (KW)	Pump Power (KW)	Total Power (KW)	Hydraulic pump station power (KW)	Water Consumption	Covered area (M2)	Number of nozzles (PCS)	Start method
DMC-25	2.2	1.1	4	0.55	10-20L/min	1744	16	Soft start/VFD start
DMC-30	3	1.5	5	0.55	12-20L/min	2512	16	Soft start/VFD start
DMC-40	7.5	2.2	10	0.55	12-20L/min	4465	40	Soft start/VFD start
DMC-50	11	3	15	0.75	40-60L/min	6977	50	Soft start/VFD start
DMC-60	18.5	4	24	0.75	60-80L/min	10048	60	Soft start/VFD start
DMC-70	22	7.5	30	1.1	90-150L/min	13676	70	Soft start/VFD start
DMC-80	37	7.5	46.6	1.1	160-200L/min	17863	80	Soft start/VFD start
DMC-100	55	11	68	2.2	240-280L/min	27911	100	Soft start/VFD start
DMC-120	75	15	93	3	120-180L/min	40192	120	Soft start/VFD start
DMC-150	90	15	108	3	300-350L/min	62800	150	Soft start/VFD start



DECENT MACHINERY

DMC-30



Sprayer Throw(M)	25-30
Hydraulic Power(Kw)	0.55
Fan Power(Kw)	3
Water Power(Kw)	1.5(Centrifugal pump)
Nozzle	16(Single Ring)
Consumption(L/min)	10-20
Droplet(μm)	30-200
Air Pressure(Pa)	1578
Air Flow(m^3/H)	14800
Impeller	6 blades (Aluminum alloy)
Material	Carbon steel--2.5mm
Size(mm)	1350*800*1766
Weight(kg)	350



DECENT MACHINERY

DMC-40

Sprayer Throw(M)	40-45
Hydraulic Power(Kw)	0.55
Fan Power(Kw)	7.5
Water Power(Kw)	3(Centrifugal pump)
Nozzle	40(Single Ring)
Flow Rate(L/min)	12-20
Droplet(μm)	30-200
Air Pressure(Pa)	2275
Air Flow(m^3/H)	34560
Impeller	6 blades (Aluminum alloy)
Material	Carbon steel--2.5mm
Size(mm)	1725*1540*1900
Weight(kg)	500





DECENT MACHINERY

DMC-50



Sprayer Throw(M)	50
Hydraulic Power(Kw)	0.55
Fan Power(Kw)	11
Water Power(Kw)	3(Centrifugal pump)
Nozzle	50(Single Ring)
Flow Rate(L/min)	40-60
Droplet(μm)	20-100
Air Pressure(Pa)	2210
Air Flow(m^3/H)	36900
Impeller	6 blades (Aluminum alloy)
Material	Carbon steel--2.5mm
Size(mm)	1725*940*2018
Weight(kg)	650



DECENT MACHINERY

DMC-60

Sprayer Throw(M)	60
Hydraulic Power(Kw)	0.75
Fan Power(Kw)	18.5
Water Power(Kw)	4(Centrifugal pump)
Nozzle	60(Single Ring)
Flow Rate(L/min)	60-80
Droplet(μm)	30-200
Air Pressure(Pa)	2275
Air Flow(m^3/H)	46800
Impeller	6 blades (Aluminum alloy)
Material	Carbon steel--2.5mm
Size(mm)	1930*1200*2122
Weight(kg)	900





DECENT MACHINERY

DMC-80



Sprayer Throw(M)	80
Hydraulic Power(Kw)	1.5
Fan Power(Kw)	37
Water Power(Kw)	7.5(Centrifugal pump)
Nozzle	80(Single Ring)
Flow Rate(L/min)	160-200
Droplet(μm)	20-100
Air Pressure(Pa)	3106
Air Flow(m^3/H)	127500
Impeller	6 blades (Aluminum alloy)
Material	Carbon steel--2.5mm
Size(mm)	2300*1400*2404
Weight(kg)	1400



DECENT MACHINERY

DMC-100

Sprayer Throw(M)	100
Hydraulic Power(Kw)	2.2
Fan Power(Kw)	55
Water Power(Kw)	15(Centrifugal pump)
Nozzle	120
Flow Rate(L/min)	240-280
Droplet(μm)	30-200
Air Pressure(Pa)	2275
Maximum Coverage Area (m ³)	20000
Impeller	Aluminum alloy
Material	Carbon steel--2.5mm
Size(mm)	2330*1600*2500
Weight(kg)	1750





DECENT MACHINERY

DMC-120



Sprayer Throw(M)	120
Hydraulic Power(Kw)	3
Fan Power(Kw)	75
Water Power(Kw)	15(Centrifugal pump)
Nozzle	100
Flow Rate(L/min)	120-180
Droplet(μm)	20-100
Air Pressure(Pa)	3106
Air Flow(m^3/H)	98400
Impeller	Aluminum alloy
Material	Carbon steel--2.5mm
Size(mm)	11200*1700*2000(with trailer)
Weight(kg)	4740(with trailer)



DECENT MACHINERY

DMC-150

Sprayer Throw(M)	150
Hydraulic Power(Kw)	3
Fan Power(Kw)	90
Water Power(Kw)	15(Centrifugal pump)
Nozzle	150
Flow Rate(L/min)	300-350
Droplet(μm)	20-100
Maximum Coverage Area (m ³)	51000
Impeller	Aluminum alloy
Material	Carbon steel--2.5mm
Size(mm)	2800*1600*2500
Weight(kg)	3000





DECENT MACHINERY

A decorative line graphic that starts with a small orange circle on the left, moves up and right, then down and right, then up and right to a peak with a small orange triangle, then down and right, then up and right, and finally a long horizontal line ending in a small orange circle on the right.

Design drawing



DECENT MACHINERY

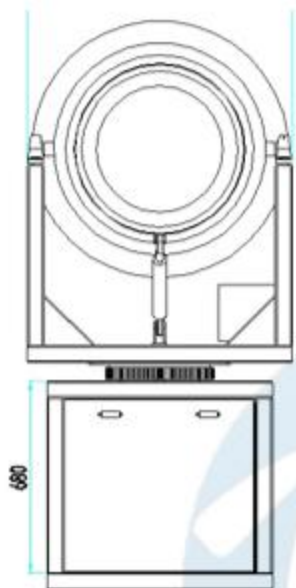

Front view

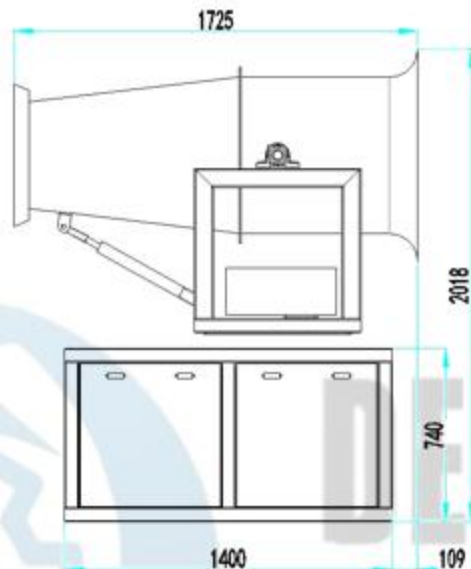

Side view

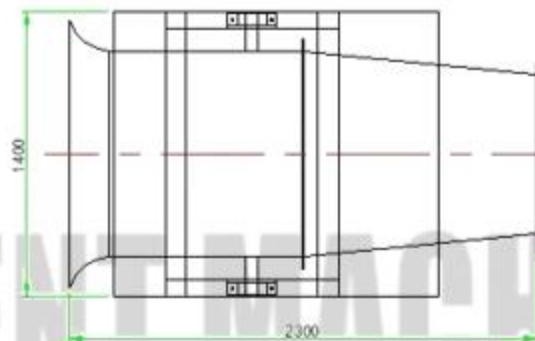

Top view



Base hole installation diagram

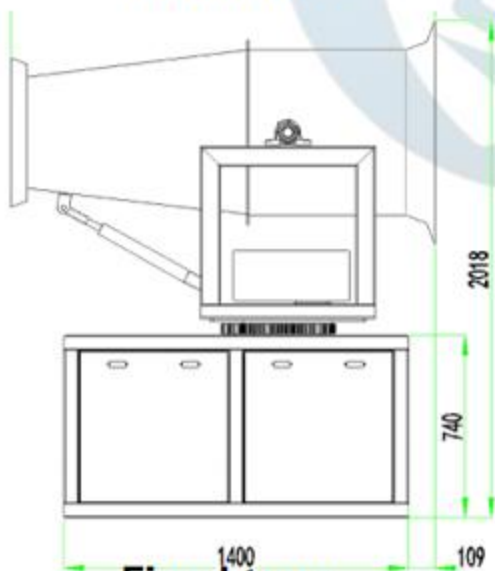

Fixed type

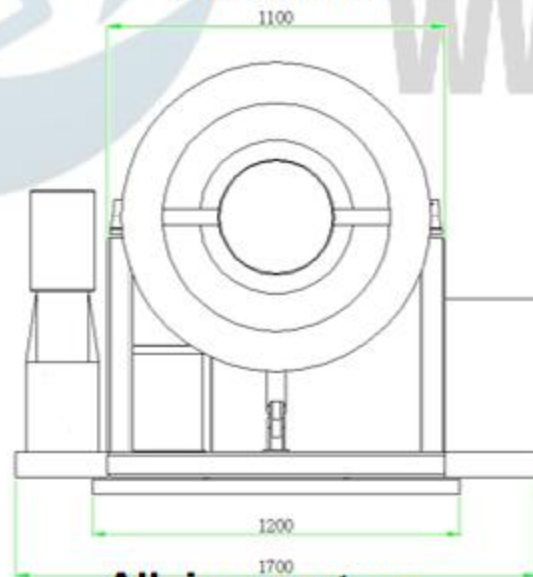

All-in-one type

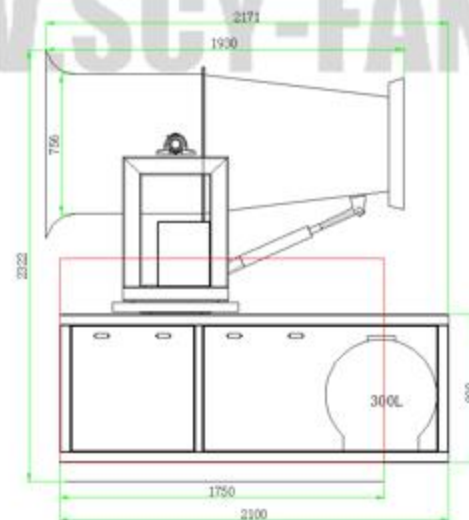

With generator and water tank type

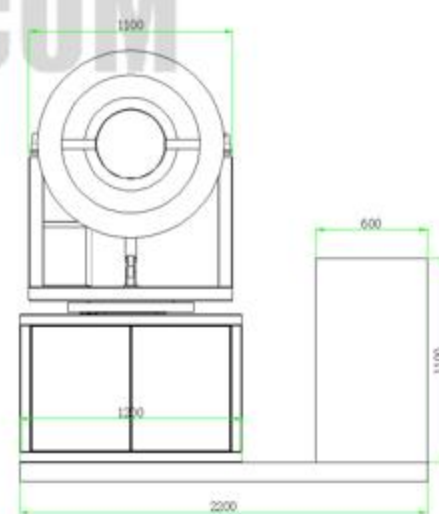

DECENT MACHINERY
WWW.SCY-FAN.COM



DECENT MACHINERY



Project List



FOREIGN PROJECT LIST

Philippines Arizona Integrated Technology, Inc.	State-owned Mining Project
Bahrain 3DI International W.L.L	Dust Collector System
Iran CHARGONBAD COPPER MINES CO	Chargonbad Mining Project
South Africa BUILD UP CITY ENTERPRISE CC.	Urban Construction Project
Bangladesh Germania Corporation Ltd.	State-owned Mining Project
Philippines Dubor Backtrennmittel UndApparatebauAG Inc.	State-owned Mining Project
Brazil Companhia Vale do Rio Doce	Environmental Protection Project
Canada NexGen Environmental Services	Renting Company
Qatar Bothar Boring&Tunnelling Operations W.L.L	Mining&Tunnelling Project
Peru Engitrade SA	Street Cleaning Project
Thailand W&G Environmental Company	Government Environmental Protection Project



DECENT MACHINERY

	Country or region
Asia	China, Thailand, Malaysia, Singapore, Philippines, Afghanistan, Yemen, Pakistan, India, Saudi Arabia, Qatar, Maldives, Bangladesh, Iran, Bahrain
Europe	United Kingdom, Italy, Ireland
North America	United States, Canada, Mexico, Jamaica, Salvador
South America	Brazil, Chile, Peru
Oceania	Australia
Africa	South Africa, Algeria, Tunisia, Kenya, Zimbabwe



DECENT MACHINERY

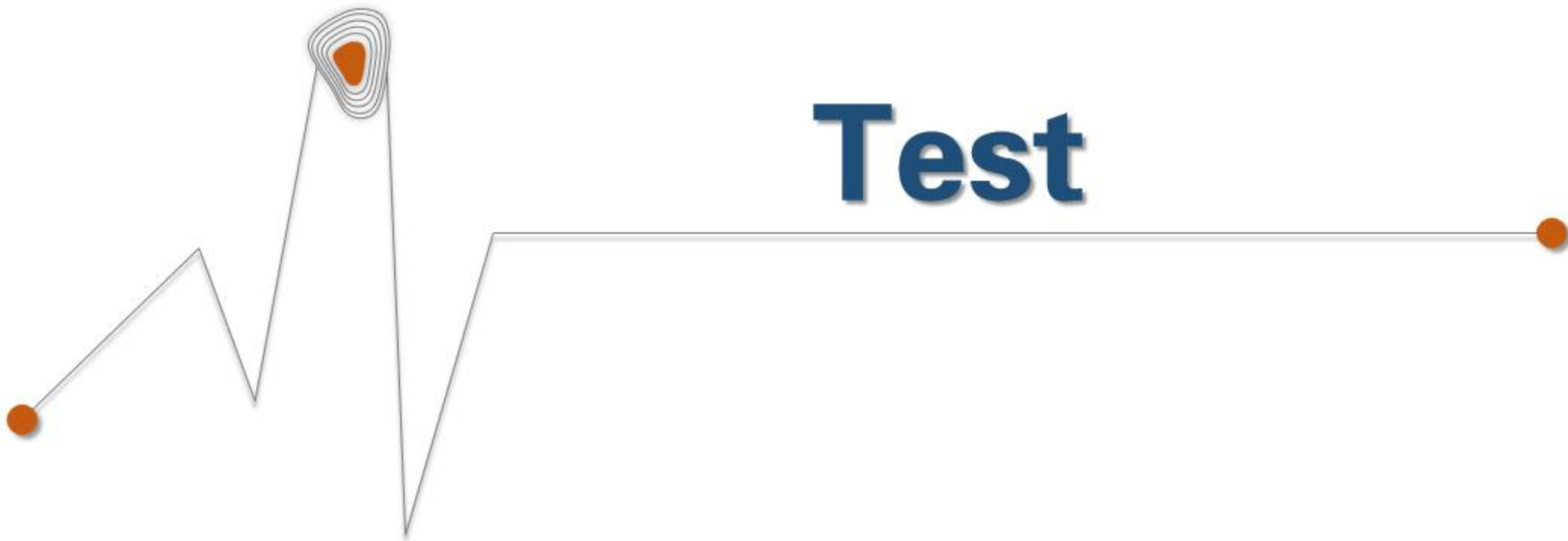

Test





DECENT MACHINERY

	INSPECTION REPORT-	Client Name: AL-HASAD AL-BALAD
	<small>THIS DOCUMENT IS NON-NEGOTIABLE</small>	Inspection No.: 10192241013
		Report Date: Aug 16 2019 Page 1 of 6

A. GENERAL			
Trade Assurance No.:	N/A	Inspection Date:	Aug 15 2019
Product Description:	MIST CANNON FOR AGRICULTURE USE	Inspection Location:	Zibo, Shandong, China
Product Item/Style:	N/A	Inspector Name(s):	Sean Song
Order quantity:	1 unit	Presented quantity:	1 unit
Total Cartons:	N/A	Selected Cartons:	N/A

B. INSPECTION OVERALL RESULT SUMMARY					
X	PASS	FAIL, Due to Beyond AQL and/or Remark _____			
	INSPECTION SECTIONS	PASS	FAIL	N/A	REMARK#
1.	Inspection Condition	X			
2.	Conformity Check <small>(Shipping Mark / Product / Labeling / Packing & Packaging / Color/Style)</small>	X			
3.	Workmanship / Appearance / Basic Function <small>(Details in Section D)</small>	X			
4.	Trade Assurance Contract Quality Requirements Check <small>(Details in Section C)</small>			X	
5.	On-Site Test <small>(Details in Section E)</small>	X			

C. REMARKS					
1.	No approval sample or reference sample was available for this inspection.				
2.	No product Specification or packaging list was available for this inspection.				
3.	No purchase order number, item number or client name information was presented on and product, so inspector could not verify if the products inspected were the client ordered.				
4.	Defect of not critical was found on product, detail as: Obvious rust mark on product 4 wheels. Coating peeled off mark on pump mixer and speed reducer (4positions). And factory claimed the defect would be repaired before delivery.				
5.	Proforma invoice was provided by factory.				

You directed that your inspection be based upon Combined sampling. Bureau Veritas advises all clients of the risks associated with "Combined Sampling" where several different product styles are combined to make a single lot size. Combined Sampling represents an increased level of risk to you as statistical rules are compromised and the chances of missing quality issues are much greater than during single style sampling. We disclaim any liability to you if you make decisions concerning the acceptance, payment authorization, or shipment of the inspected goods based upon Combined Sampling.

During inspection, the color evaluation was performed by inspector in the inspection room under normal day light or other light sources specified by client. The evaluation & grading are preliminary based on factory lighting conditions at time of inspection. For accurate rating & results, color conformity should be performed by a qualified technician in a laboratory under a standard environment.

D. WORKMANSHIP (Basic Function & Appearance)			
Inspection Standard:	ANSI/ASQ Z1.4 (formerly known as MIL-STD-105E)		
Inspection Level - Workmanship / Visual:	Others	Acceptance Quality Limit(AQL) - Critical Defectives:	Not Allowed
Sampling Plan - Workmanship / Visual:	Single /	AQL - Major Defectives:	N/A

This document reflects our findings at the time and place of inspection, which was conducted by means of comparing reference products and documents against samples that are randomly picked in accordance with an agreed random statistical sampling standard from the lots of finished products presented to our inspectors. This comparison was done in accordance with agreed inspection protocol and/or other agreement.
 If certain methods and processes which vary or deviate from the standard and/or recommended practices of Bureau Veritas Consumer Product Services were adopted for the performance of this inspection at the request of the client, Bureau Veritas Consumer Product Services is not liable for the possible compromise of the recorded observations due to such variations of deviations.
 This report/certificate does not discharge or release sellers/suppliers from their commercial, legal or contractual obligations with regard to quality/quantity of delivery nor does it prejudice the buyer's right of claim toward sellers/suppliers for compensation for any defects (apparent or otherwise) not detected during our random inspection or occurring thereafter.
 Bureau Veritas does not accept any liability for the quality of products in this shipment that were not produced at the time of the inspection taking place. Further, this report/certificate does not evidence shipment.
 Our services, including reports and certificates, are subject to the Bureau Veritas Consumer Products General Conditions of Service of which have been sent to your company. They can be found upon request.
 Bureau Veritas Consumer Products Services Shanghai Co., Ltd.
 2nd Floor, Building A, No.368 Guangzhong Road, ZhuanQiao Town, Minhang District, Shanghai, China
 "BUREAU VERITAS PROPRIETARY - unpublished work, copyright [2013] Bureau Veritas - DO NOT DISCLOSE OUTSIDE YOUR ORGANISATION WITHOUT BUREAU VERITAS PRIOR WRITTEN CONSENT".

	INSPECTION REPORT-	Client Name: AL-HASAD AL-BALAD
	<small>THIS DOCUMENT IS NON-NEGOTIABLE</small>	Inspection No.: 10192241013
		Report Date: Aug 16 2019 Page 3 of 6

Photo 4) Product view	Photo 5) Product view	Photo 6) Printed mark on product
Photo 7) Printed mark on product	Photo 8) Product details view	Photo 9) Component name board
Photo 10) Component name board	Photo 11) Product details view	Photo 12) Component name board
Photo 13) Product details view	Photo 14) Product details view	Photo 15) Product details view

This document reflects our findings at the time and place of inspection, which was conducted by means of comparing reference products and documents against samples that are randomly picked in accordance with an agreed random statistical sampling standard from the lots of finished products presented to our inspectors. This comparison was done in accordance with agreed inspection protocol and/or other agreement.
 If certain methods and processes which vary or deviate from the standard and/or recommended practices of Bureau Veritas Consumer Product Services were adopted for the performance of this inspection at the request of the client, Bureau Veritas Consumer Product Services is not liable for the possible compromise of the recorded observations due to such variations of deviations.
 This report/certificate does not discharge or release sellers/suppliers from their commercial, legal or contractual obligations with regard to quality/quantity of delivery nor does it prejudice the buyer's right of claim toward sellers/suppliers for compensation for any defects (apparent or otherwise) not detected during our random inspection or occurring thereafter.
 Bureau Veritas does not accept any liability for the quality of products in this shipment that were not produced at the time of the inspection taking place. Further, this report/certificate does not evidence shipment.
 Our services, including reports and certificates, are subject to the Bureau Veritas Consumer Products General Conditions of Service of which have been sent to your company. They can be found upon request.
 Bureau Veritas Consumer Products Services Shanghai Co., Ltd.
 2nd Floor, Building A, No.368 Guangzhong Road, ZhuanQiao Town, Minhang District, Shanghai, China
 "BUREAU VERITAS PROPRIETARY - unpublished work, copyright [2013] Bureau Veritas - DO NOT DISCLOSE OUTSIDE YOUR ORGANISATION WITHOUT BUREAU VERITAS PRIOR WRITTEN CONSENT".

BV Test Report





DECENT MACHINERY



Package



DECENT MACHINERY

FCL

We have enough packing experience and can provide packing solutions.

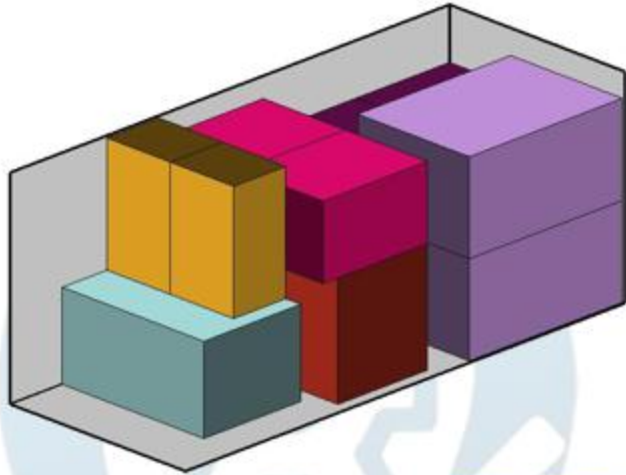

Packing

LCL

Packed in plywood wooden box, reinforced and filled





DECENT MACHINERY



Certificate



DECENT MACHINERY

Certificates

HTT SHENZHEN HTT TECHNOLOGY CO., LTD.
HOTLINE: 400-822-2114
WWW.HTTTECH.COM

Certificate of Compliance

Certificate No. : HTT18091090L
 Applicant : ZIBO DECENT MACHINERY CO.,LTD
 Applicant Address : No.415,Block C,Xincheng Center Zhangqian,Zibo, Shandong,China
 Manufacturer : ZIBO DECENT MACHINERY CO.,LTD
 Manufacturer Address : No.415,Block C,Xincheng Center Zhangqian,Zibo, Shandong,China
 Product : Dust removal ventilation fan blower
 Model No. : 4-6S, 4-7J, 4-7J, 9-16, 9-18, CS-4S, GD30K2-12, T60, 04-7J, 04-6S, Y4-6S, W4-6S, YBT, FBO, FBCDZ, (DJK404S, SR series, L series, FX Series, DMC series
 Trademark : Decent

The above products have been tested by us with listed standards and found in compliance with the council MD (Machinery Directive) 2006/42/EC. It is possible to use CE marking to demonstrate the compliance with this Machinery Directive.

Test standards	Report's Number	Issued By	Issued Date
EN6034 0,396-A 0,399	HTT 08019004L R	HTT	Aug-07-2018

This certificate of conformity is not transferable and based on an evaluation of a sample of the above mentioned product.

Authorized Signer: *Kevin Yang*
Kevin Yang, Senior Manager

Date: Sep-07-2018

TEL: +86-530-200000 FAX: +86-530-200000
 7F, A BUILDING, HUADEYI VALLEY WUJING AVENUE ZIBO ZHONGYUAN INNOVATION PLAZA,
 252000, ZIBO CITY, SHANDONG PROVINCE, P.R. CHINA

WANT

Quality management system certification certificate

Certificate number: 071582827990
 Unified social credit Code: 91370309MA3C8T7F18

This is to certify that
ZIBO DECENT MACHINERY CO.,LTD.
 Huaxiao Building,Zhangqian,Zibo,Shandong Province

The organization's management system fits
 GB/T19001-2016 / ISO9001:2015

Scope of authentication
 Mechanical mechanical hardware equipment certification dust removal equipment installation take water for stone equipment form equipment distribution equipment spray equipment maintenance building materials and accessories accessories import and export of technology import and export business information consulting guide judgment in accordance with the project, the related department approval to operate.

Certificate registration date: 13/5/2020 Certificate validity: 12/5/2023

During the validity period of the certificate, the certificate shall be valid only if the qualified staff of supervision and audit is posted at the designated location of the certificate every 12 months. After status of the certificate Please over the open right of code or sign (www.e-poem.cn) for query.

Certificate issuer: *王新元*

IAF CNAS

WANTING INTERNATIONAL CERTIFICATION SERVICES (CHINA) CO.,LTD.
 www.e-poem.cn

SGS Made-in-China.com
 Connecting Buyers with Chinese Suppliers

Report Number: QIP-ASI190043 Audit Date : 17 Jan, 2019

This report is issued by Focus Technology Co., Ltd. (Made-in-China.com) and the supervising inspectorate (SGS-CSTC Standards Technical Services Co., Ltd.) to confirm that:

Company Name : Zibo Decent Machinery Co., Ltd.
 淄博德成机械设备有限公司
 Showroom : <http://ziboecent.en.made-in-china.com>
 Address : Room 401, Unit 2, Building 36, Shangwenyuan Community, Zhangqian, Zibo, Shandong, China
 Product : Semi Trailer, Loader, Ventilator Products, Mine Equipment

has been on site audited for the Following Scope of Activity

1. General Information
2. Foreign Trade Capacity
3. Product Research & Development Capacity
4. Management System and Product Certification
5. Working Environment
6. Photos

General Comments:
 Zibo Decent Machinery Co., Ltd., established in 2016, is a trader with 8 employees. The company locates in Room 401, Unit 2, Building 36, Shangwenyuan Community, Zhangqian, Zibo, Shandong, China and the office occupy an area of 300 square meters. Zibo Decent Machinery Co., Ltd. has successful foreign trading experience in North America, South America, Europe, etc.

Yating
 Sign for and on behalf of
 SGS-CSTC Standards Technical Services Co., Ltd.

Page No. 1 of 12

BUREAU VERITAS Made-in-China.com
 Connecting Buyers with Chinese Suppliers

Report Number: MIC-ASR205789 Audit Date : 15 Jul, 2020

This report is issued by Focus Technology Co., Ltd. (Made-in-China.com) and the supervising inspectorate (Bureau Veritas) to confirm that:

Company Name : Zibo Decent Machinery Co., Ltd.
 淄博德成机械设备有限公司
 Showroom : <http://ziboecent.en.made-in-china.com>
 Address : Room 2205, Huaxiao Building, Zhangqian District, Zibo City, Shandong Province, China
 Product : Fan Blower, Fog Cannon, Roots Blower, Dust Collector, Air Handling Unit

has been on site audited for the Following Scope of Activity

1. General Information
2. Foreign Trade Capacity
3. Product Research & Development Capacity
4. Management System and Product Certification
5. Working Environment
6. Energy Saving and Emission Reduction
7. Industry Information
8. Photos

General Comments:
 Zibo Decent Machinery Co., Ltd. has 11 employees; it was established in 2016, located in Room 2205, Huaxiao Building, Zhangqian District, Zibo City, Shandong Province, China. The company occupy an area of 100 square meters. This company has its own brand "DECENT MACHINERY". The company has successful foreign trading experience in Europe, South America, North America, Southeast Asia, Middle East, Africa, Australia and Asia.

Yating
 Sign for and on behalf of
 Bureau Veritas

Page No. 1 of 17





DECENT MACHINERY

Operation

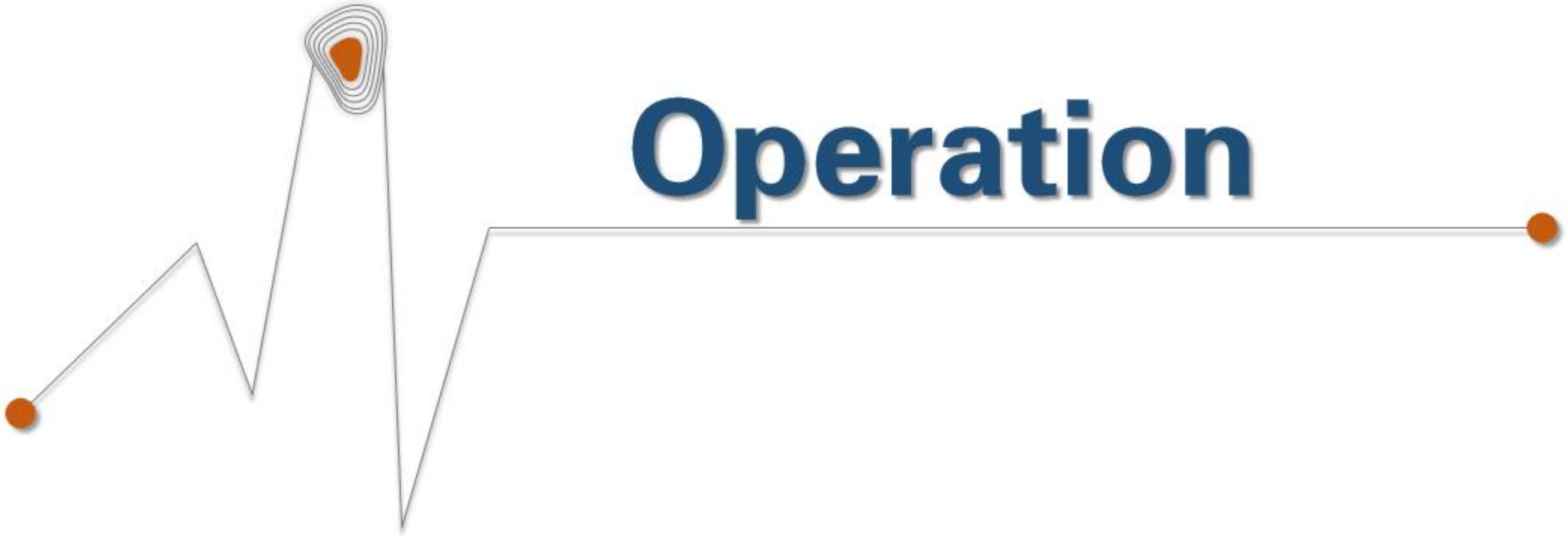



1. Preparation before starting:

- First check whether the diesel fuel, lubricating oil and cooling water are sufficient.
- Whether the power cord for diesel engine start is tightly connected with the battery terminal.
- Whether the power switch on the generator set is in the divided state.
- Whether the liquid supply pipelines are tightly connected, turn on the control switches on the liquid supply pipelines of the spray cylinder.

2. Diesel engine start:

- Turn the start key to the start position, press the electric start motor button and wait for the generator set to run slowly for 1-2 minutes, then gradually increase the throttle so that the voltage reaches 420 volts (fan start voltage). The normal use voltage is At 380 volts, the cycle meter is at the 50 Hz position, and the main power switch is turned up to the "on" state.

3. Trial operation of the fan:

- When the generator set is running normally, turn the power switch on the electric control box to the ON position, remove the dust and fog gun, and press the electric "fan on" button on the electric control box or the remote control, and wait for the fan After normal operation, twist the phase voltage detection knob on the electric control box to check whether the voltage of each phase line is balanced.



4. Trial operation of the sprayer:

- After the fan is running normally, you can click the "pump on" button on the electric control box or the remote control. After the liquid is sprayed, check whether the liquid supply pipes and nozzles are leaking, and whether the nozzle sprays mist Average, if not, adjust the nozzle by twisting; check whether the pointer of the hydraulic pump pressure gauge meets the requirements of the technical data.

5. When spraying:

- you can adjust the horizontal spray angle and pitch angle according to your needs. The horizontal twist can be adjusted by pressing the "left" or "right" button on the electric control box or on the remote control. The pitch angle can be adjusted in the electric Click the "up" or "down" button on the control box or remote control to adjust; the liquid is sprayed from the nozzle to the nozzle of the nozzle through the liquid pump and sprayed to the object after being broken by the wind.
- When the spray canister turns to the set angle horizontally and touches the travel switch (limit switch), it will automatically stop rotating. If you need to turn to another target to spray, you should wait for 2-3 seconds. Press the other target button again; if you need to automatically orbit and spray back and forth, you can twist the "orbiting reciprocating" on the electric control box, and click the "left" or "right" button, then the nozzle can achieve orbit Automatic reciprocating rotation.



DECENT MACHINERY

Maintenance

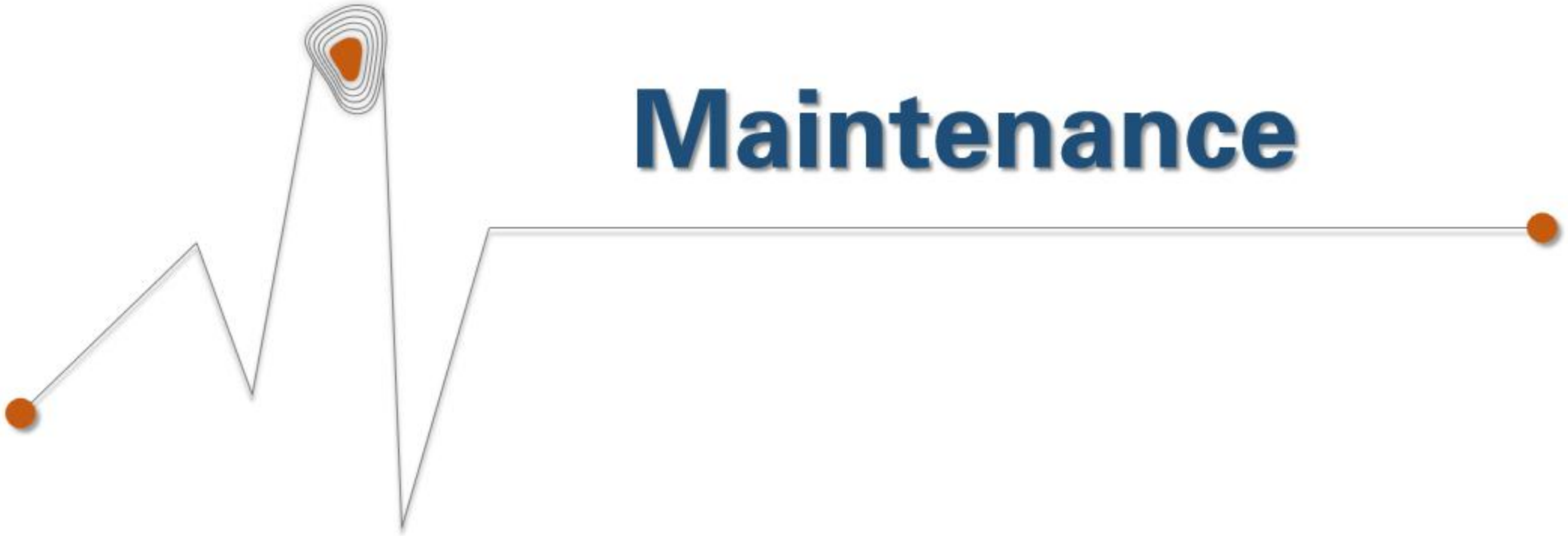



Motor maintenance:

- The operating environment should be kept dry, the surface of the motor should be kept clean, and the air inlet should not be obstructed by dust and fibers;
- When the motor thermal protection and short circuit protection continue to operate, it is necessary to find out whether the fault is caused by the motor or the motor overload or the setting value of the protection device is too low, and the fault can be put into operation after troubleshooting;
- It should be ensured that the motor bearings are well lubricated during operation. Generally, the grease should be added or replaced after the motor has been running for 2000 hours or 6 months.





Nozzle maintenance:

- Use #16 fork wrench and #4 allen wrench to disassemble the nozzle, pay attention to the order of disassembly, and the internal structure cannot be installed wrongly during installation.

- Use diesel oil or special cleaner to clean the dirt inside. After cleaning, wrap the raw material tape and install it on the spray pipe





DECENT MACHINERY



Maintenance of water pump:

- Structure description of high pressure plunger pump
- 1) Check each fastener to make sure that the pump and motor are stable and reliable
- 2) The two pulleys should be installed in a straight line, and the belt should be moderately tight
- 3) Each joint of the pipe must be locked to prevent leakage
- 4) Start the motor, make the water pump run and maintain the proper operating speed, adjust the pressure screw to keep the pressure between 21-35 kg (the spray gun has been adjusted before leaving the factory)
- Maintenance of high pressure plunger
 - 1) Change the oil of the high-pressure plunger pump during the first 10 hours to 50 hours of use, and change the oil every 70 hours thereafter
 - 2) The butter cup is often filled with butter, and the butter cup should be rotated 2 to 3 times every 2 hours of use



Precautions for fans

- Pay attention to regular visual inspection to see if the screw at the connection between the fan and the motor is loose or detached. If there is any looseness or detachment, the fan should be stopped immediately to prevent accidents.

Precautions for water pump

- Pay attention to rigorous idling operation for a long time when starting
- When the water pump is not used in winter or frost period, the liquid in the water pump must be drained to prevent the water pump from being damaged by freezing. Use the drain valve on the head of the pump to drain the water, and close the drain valve after the water is drained.



DECENT MACHINERY

FAQ

A decorative graphic consisting of a thin grey line that starts with a small orange circle on the left, rises to a peak with a small orange triangle inside a series of concentric grey circles, then descends and levels off into a horizontal line ending with another small orange circle on the right.

DECENT MACHINERY



DECENT MACHINERY

Q1: We will use the machine in truck so we will use truck battery to get electric. How many volt machine will need to work from truck battery?

A1: If you want to use it on a truck, the most guaranteed method is to add a generator set, the voltage is the same as the machine voltage.

Q2: How do we know the delivery progress before leaving the factory?

A2: We can online remotely watch the factory, allowing customers to more intuitively feel the delivery.

Click here to view the video of remote supervision of delivery. We have adopted this method with customers in the UK, Peru, Thailand, etc.

Q3: What about liquid tank capacity?

A3: Each model has a different water tank capacity, such as the water tank capacity of 30m fog cannon is 150L.

Click here to view the specific capacity of each model.

Q4: I want the fog cannon body to be orange and the base to be black, okay?

A4: Sure, of course, we can customize any color for you.

Click here to view the picture of our previous design for Canadian customer, same as the orange body and black base.

Q5: How many nozzles are there? possible to increase to perhaps 2 layers, 40 and 40 for 50m fog cannon?

A5: Sure, no problem, we can customized number of nozzles according to customer's specific request.

Click here to view the picture of our nozzle and another parts.

Q6: Our local voltage is 220V 60HZ 3P, do u meet my request?

A6: Yes, we support customized the motor voltage, which can be changed to 220V 60HZ 3P/220V 60HZ single-phase/240V 6HZ 3P/380V 50HZ 3P/380V 60HZ 3P/420V 50HZ 3P/460V 60HZ 3P, etc.



Q7: We need high stand 6m, what about high stand? Is it possible?

A7: We have had relevant experience before, which is to place fog cannon on a 10-meter high stand, so 6 meters is fine.
Click here to view our view our high platform design.

Q8: What types of fog cannon are there?

A8: According to the use environment, it is divided into light type, road (garden, orchard) disinfection type, heavy type, industrial type, and mining type. According to the placement type, it is divided into fixed and vehicle-mounted.
Click here to view our fog cannon classification.

Q9: We want to use PLC control, can it be achieved?

A9: Yes, we can use PLC to achieve fixed-point spraying. And there are servo motors to choose from

Q10: How many bar of the pressure pump?

A10: such as 60m pump pressure is about 1.5mpa. 80m pump pressure is about 2mpa. 100m pump pressure is about 3.5mpa.

Q11: Which famous company have you worked with?

A11: We worked with Brazil's Vale (the world's second largest mining company) in 2015. And their technology has visited our factory.
Click here to view the specific project introduction.

Q12: I need to lower the temperature, sometimes the temperature reaches 50 degrees, how much can the temperature be lowered?

A12: If you use cold water, such as well water, the temperature can be reduced to about 30 degrees.



DECENT MACHINERY



Decent Team



DECENT MACHINERY

1

Sales Person will help you

- get the offer
- know the details
- get the drawings
- Sort out the requests



Purchasing Department

- Famous motor:ABB, siemens, TECO, WEG
- Raw material: carbon steel and stainless steel
- Water Pump: Multistage centrifugal pump
 - high pressure plunger pump
- Control method: PLC control optional

2

Production department

- Technical confirmation before production
 - Produce on request
- Testing before leaving the factory
 - Packing

3

Team

4

Transportation department

DECENT MACHINERY
WWW.SCY-FAN.COM



DECENT MACHINERY

Customer Collection



